

TRUST
Over **IP**
FOUNDATION

THE **LINUX** FOUNDATION

All Members Monthly Meeting

Working Group Updates

Wednesday, May 18, 2022
10:00-11:00 am PT / 17:00-18:00 UTC

Antitrust Policy & Member Participation

- › Attendees are reminded to adhere to the meeting agenda and not participate in activities prohibited under antitrust and competition laws*
- › Only members of Trust Over IP who have signed the necessary agreements and charters are permitted to participate in this activity beyond an observer role

* Examples of types of actions that are prohibited at Linux Foundation meetings and in connection with Linux Foundation activities are described in the Linux Foundation Antitrust Policy available at <http://www.linuxfoundation.org/antitrust-policy>

Agenda

- Agenda Review (1 min)
- Welcome New Members (1 min)
- Foundation Wide Updates and Announcements (2 min)
- Working Group Updates
- Open Discussion

New Members Review

304 Organizations
131 Individuals

<u>Contributor Organizations</u>	<u>Contributor Individuals</u>	<u>General Members & Steering Committee</u>
Procivis AG	Joachim Miller	Monokee
Roots Wallet	Viivi Lahteenoja	
Genesis Studio	Jovaughn Lock	
Datasoc Ltd	Debbol Shenkute	
Sezoo	Denis Laroache	
Social Market Technology Network	Hannah Sutor	
Perey Research		
Hashedworks		
Government of Western Australia		



Foundation Wide

Updates & Announcements

Conferences

- EIC (May 10th-13th) ToIP Panel – Berlin Germany **May 11th**

Big Success:

Well attended, Lots of Questions afterward, asked to sit on closing GAIN Panel

- RSA's (June 6th-9th San Francisco CA)
- Identiverse (June 20th-23rd Denver, Colorado)
- My Data (June 21st-22nd, Helsinki)
- London Identity week (June 28th-29th)

- Hyperleger Global Forum (Centre Dublin, Dublin, Ireland Sept 13
Toip will be present as a Community Partner
- Open Source Summit Europe ToIP-Mini-Summit
(Centre Dublin, Dublin, Ireland Wednesday, Sept 14, 2022)

All Members Special Topic

IAM and SSI: A Combined Approach to Digital Identity

Gabe Albert, and Lexi Ashpole, Accenture

June 15th 10am PT

Conferences

- EIC (May 10th-13th) ToIP Panel – Berlin Germany **May 11th**

Big Success:

Well attended, Lots of Questions afterward, asked to sit on closing GAIN Panel

- RSA's (June 6th-9th San Francisco CA)
- Identiverse (June 20th-23rd Denver, Colorado)
- My Data (June 21st-22nd, Helsinki)
- London Identity week (June 28th-29th)

- Hyperleger Global Forum (Centre Dublin, Dublin, Ireland Sept 13
Toip will be present as a Community Partner
- Open Source Summit Europe ToIP-Mini-Summit
(Centre Dublin, Dublin, Ireland Wednesday, Sept 14, 2022)



Working Group Updates

Ecosystem Foundry Working Group

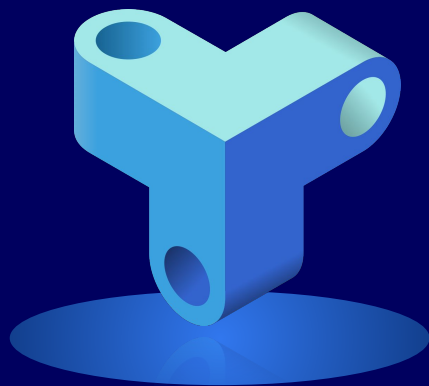

New at the EFWG

Case Studies: Three case studies to date, posted on the Wiki
<https://wiki.trustoverip.org/pages/viewpage.action?pagelD=19640634>

Youtube: Meetings of EFWG are available on the youtube channel
https://www.youtube.com/channel/UC7gD2mHX_AXzKTHelj2nYEA

Resource Directory: Systems Integrators, Independent Software/Hardware Vendors, Consultants, Lawyers & Auditors, Research Organisations
<https://wiki.trustoverip.org/pages/viewpage.action?pagelD=19633443>

Learning Pathways: The Learning Pathways Task Force's goal is to add value to the content by organizing ToIP created content into Learning Pathways which will give learners a clear path through a (short) training program.
<https://wiki.trustoverip.org/display/HOME/Learning+Pathways+Taskforce>

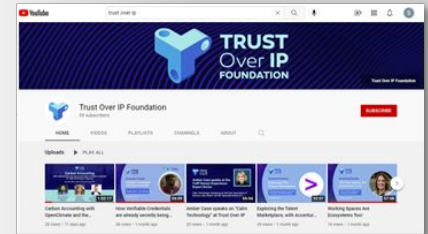

Ecosystem Governance Task Force

- Seeking leadership for this task force
- Organizing at slack: #layer4-governance-tf
- Building on work from Governance stack working group led by Scott Perry, and governance model work by Stephen Curran @ BC Gov
- Join the slack channel and express your interest in contributing

Whitepaper - Biological Ecosystems

- Trinh has taken the lead writing and has prepared a complete draft
- See [#ecosystem-foundry-wg](#) slack channel for links and details



Presentation Series

 UpNext



Decentralized Identification using Verifiable Credentials

26 May 2022



Get Involved

Making human trust part of every digital solution

We're always looking for suggestions or contacts for speakers and presentation subjects: please send them our way if you have any ideas!



Meeting Time -EFWG

Every Alternate Thursday

8am PDT / 11am EST / 15:00 UTC / 17:00 CEST

Subscribe on the ToIP Meeting Calendar

<https://wiki.trustoverip.org/display/HOME/Calendar+of+ToIP+Meetings#space-menu-link-content>

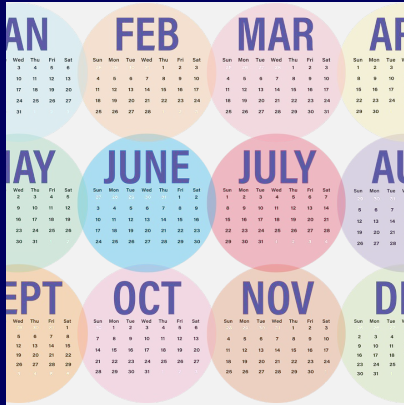

Governance Stack Working Group

- Created Generic Governance Template Documents for Use at All Layers
 - Primary Document / Companion Guide
 - Requirements / Companion Guide
- Held Governance 101 Webinar - from Conception through Governance Documents
 - Meeting Recording:
 - <https://zoom.us/rec/share/XvLHsVvQeX--ecg-fJxkNptVIVFpzXEhHzrNySDXhrgNYbNUhOdb9y-z5rMk0Q1B.iie4ijBHsyXldFSw>

Governance Stack Working Group

- **Launched Layer - Specific Governance Task Forces**
 - Layer One - Alex Tweeddale, In Operation
 - Layer Two - Unassigned, Idle
 - Layer Three - Kyle Robinson, Yet to Start
 - Layer Four - Carly Huitema & EFWG, Stephen Curran provided starter template



Meeting Time -GSWG

Every Alternate Thursday

11:00 Pacific / 14:00 Eastern / 18:00 UTC

Learning Pathways Task Force

Every Alternate Thursday

11:00 Pacific / 14:00 Eastern / 18:00 UTC

Subscribe on the ToIP Meeting Calendar

<https://wiki.trustoverip.org/display/HOME/Calendar+of+ToIP+Meetings#space-menu-link-content>

Technology Stack Working Group

- Current focus is the **ToIP Technology Architecture Specification V1**
- ToIP Technology Architecture Task Force is meeting twice each week (NA/EU at 14:00 UTC, APAC at 20:00 UTC)
- Have developed a generalized reference architecture for defining the four layers of the ToIP Technology Stack
- Wenjing Chu presented this reference architecture at the Internet Identity Workshop (IIW) April 26-28—it was very well received
- Now in the process of adding the details and requirements necessary to complete the V1 spec

Generalized Reference Architecture

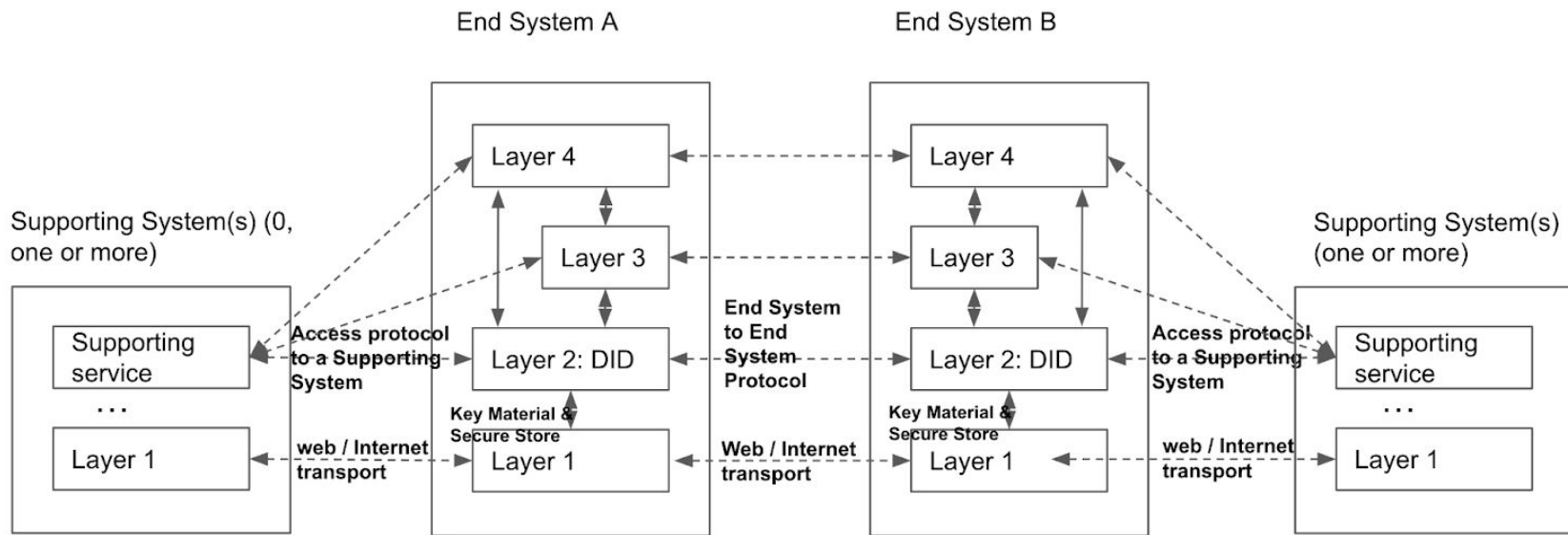

Meeting Time -TSWGG

Every Alternate Monday

08:00 Pacific / 11:00 Eastern / 15:00 UTC



Tech Arch Task Force

Two meetings every Thursday

NA/EU — 07:00 Pacific / 10:00 Eastern / 14:00 UTC

APAC — 13:00 Pacific / 16:00 Eastern / 20:00 UTC

Subscribe on the ToIP Meeting Calendar

<https://wiki.trustoverip.org/display/HOME/Calendar+of+ToIP+Meetings#space-menu-link-content>

Utility Foundry Working Group

Ongoing work items

- [Public Utility Directory](#)
 - This is a list of all the active Layer 1 utilities which currently have representative members at ToIP
- [A Framework for Evaluating Layer 1 Utilities - Overview](#)
 - This document identifies the key differences and considerations between the core Layer 1 utilities for clients/customers looking to adopt a ToIP compatible SSI solution
 - Includes a rubric
 - In final review stages

Utility Foundry Working Group

New/Future work items

- Combine efforts with the **Layer 1 Governance Task Force**.
 - That task force will meet with and become a regular part of our bi-weekly UFWG meetings since the goals of the task force match very closely with our goals.
 - The Task Force intends to put together a Template for Layer 1 Governance Frameworks
 - This will be informed by the work the UFWG has completed in its deliverable [A Framework for Evaluating Layer 1 Utilities - Overview](#)
- Specific deliverable on [Decentralised Identity Architecture and Regulatory Compliance](#)

Meeting Time -UFWG

Every Alternate Tuesday

11:00 Pacific / 14:00 Eastern / 18:00 UTC

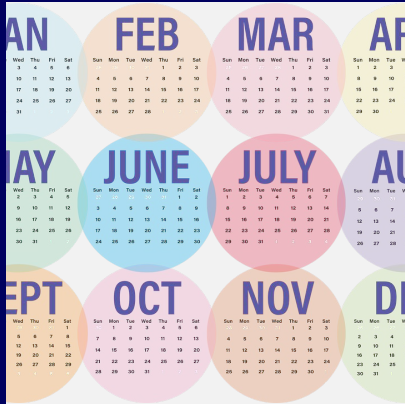

Subscribe on the ToIP Meeting Calendar

<https://wiki.trustoverip.org/display/HOME/Calendar+of+ToIP+Meetings#space-menu-link-content>

Inputs & Semantics Working Group

Working Group Priorities

- Alignment of Dynamic Data Economy (DDE) models, concepts, and technologies with the more familiar Self-sovereign Identity (SSI) models.
- Continued use case alignment:
 - KERI (Inputs domain) and OCA (Semantic domain) principles
 - Data governance administrations (EU Data Gov. Act, MyData Operators, Data services/components, “Intermediaries”)
 - Distributed data ecosystems
- DDE v1.0 and OCA v1.0 due for internal review end of May / early June which will likely trigger a migration of *Decentralised Semantics* to a more data-centric (as opposed to identifier-centric) community to maintain momentum
- Data Governance Compliance - impact on SSI/DDE. Potential solutions.
- Next ISWG monthly meeting: June 14th @ 17.00 UTC

Inputs & Semantics Working Group

Active Working Group and Task Forces

- **Storage & Portability TF** [Chair: C. Fabianek / Vice-Chair(s): A. Smajic; J. Simmons]
 - Processing a community list of *Storage and Portability* topics with the flexibility to address current events in this space.
 - Next SPTF bi-weekly meeting: **May 23rd @ 17.00 UTC**
- **Notice & Consent TF** [Chair: M. Lizar / Vice-Chair: S. D'Agostino]
 - First draft of the Privacy Controller Credential specification for Decentralized Data Governance due in Q1
 - Next NCTF bi-weekly meeting: **May 26th @ 15.30 UTC**
- **Privacy & Risk TF** [Chair: J. Lindquist / Vice-Chair: B. Serdar]
 - Processing a community list of *Privacy and Risk* topics with the flexibility to address current events in this space.
 - Next PRTF bi-weekly meeting: **May 30th @ 17.00 UTC**
- **Inputs & Semantics WG** [Chair: P. Knowles / Vice-Chair: N. Thomson]
 - In-depth discussions on structural and contextual integrity of digital objects and factual authenticity of logged events.
 - Next ISWG bi-weekly meeting: **June 14th @ 17.00 UTC**

Meeting Times - ISWG

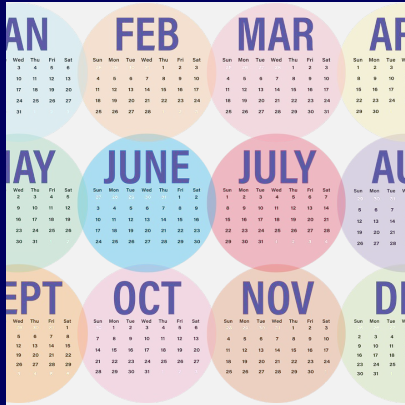

ISWG - Every Alternate xxx

XX:00 Pacific / xx:00 Eastern / xx:00 UTC

Task Force XXXX Every xx

XX:00 Pacific / xx:00 Eastern / xx:00 UTC

Subscribe on the ToIP Meeting Calendar

<https://wiki.trustoverip.org/display/HOME/Calendar+of+ToIP+Meetings#space-menu-link-content>

Human Experience Working Group



Expert Series

- February: Lisa Talia-Moretti, Digital Sociologist, '[Dear Human, the Future Needs You](#)', [Practical Ethics](#).
- March: Amber Case, HCI specialist, '[Calm Technology](#)', [designing for the next generation of devices](#).
- May: Arianna Rossi & Xengie Doan '[How Might we Design Consent Experiences for Data Sharing?](#)' ([editing in progress](#))
- **19 May:** **AGENCY Project:** *Reducing complex online harms using user-centred tech and governance.* Dr Karen Elliot (Associate Professor & Senior Lecturer in Enterprise/Innovation (FinTech)) & Professor Aad van Moorsel (Professor of Distributed Systems) both from Newcastle University (UK).
- **June:** *draft placeholder for Designing for Identity of Things* [TBC]

[Upcoming]: "Interview the Implementer" - first guest will be **Dan Gisolfi**. Submit Questions at [HXWG Slack](#).

Update on other deliverables:

- Video intro to HXWG by end April (delayed, contractor pricing)
- An Introduction to Building & Using Scenarios by end May (ongoing)
- LinkedIn Events + YouTube Channels are now up (thank you CommsComm, Judith, Elisa, WG chairs and all who embraced the ideas and made it happen). Resources on [ToIP Wiki](#) and [ToIP Youtube](#).

In our quest to reach *#slowburn* state with steady deliverables, we are in searchlight mode: huge thank you to Phil Wolff, Kyle Robinson, Mike Lazar for contributing to our discussions

Human Experience Working Group

The Task Force Formerly Known As #SSI Harms
is now

Balancing the Good, The Bad & The Ugly of SSI (BGBU)

- Meeting since March with at alternating US/EU/APAC times
- First harms identified and surfaced
- Storyboard now in progress [\[here\]](#)

Deliverables: White Paper and practical tools/guidance for ToIP members

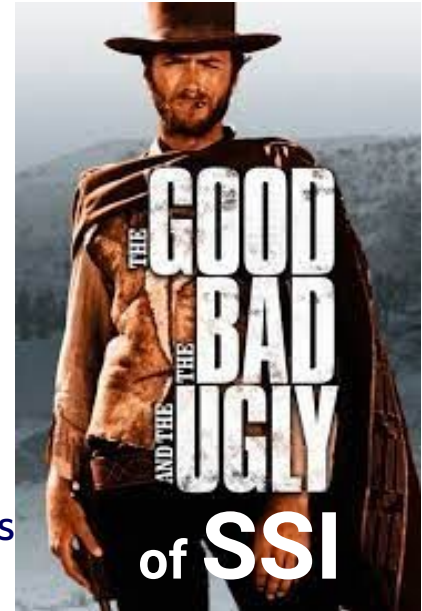

Meeting Times - HXWG

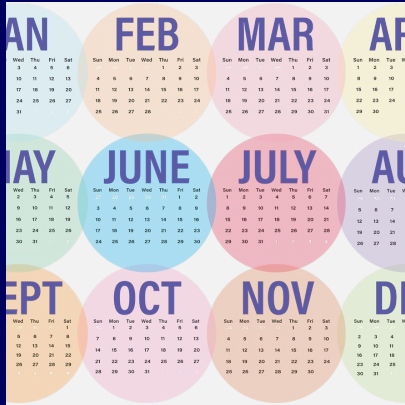

HXWG - Every Alternate Thursday
9:00 Pacific / 12:00 Eastern / 16:00 UTC
Next call is **Thursday 19th May**

Task Force BGBU
USA / EU / Africa Every Alternate Monday
9:00 Pacific / 12:00 Eastern / 16:00 UTC
Next call is **Monday 28th March**

Asia & Australasia Every Alternate Thursday
18:00 AEDT / 14:00 Indochina / 12.30 IST / 7:00 UTC
Next call is **Thursday 17th March**

Subscribe on the ToIP Meeting Calendar

<https://wiki.trustoverip.org/display/HOME/Calendar+of+ToIP+Meetings#space-menu-link-content>

Concepts & Terminology Working Group

- Still working on first generation terms wikis and glossaries
 - ToIP Core
 - CTWG
 - GSWG
 - Yoma
- Continued collaboration with eSSIF-Lab Glossary
- Reviewing proposals for second generation functionality

Concepts & Terminology Working Group

- Next Steps
 - Continue “backfill” of ToIP Core and GSWG glossaries for all terms used the GSWG deliverables
 - Prepare a terms wiki and glossary for the ToIP Technology Architecture Specification (TSWG)
 - Continue planning work for ToIP Term Tool V2
 - Terminology corpus curation tools
 - Document auto-markup tool (will add links and pop-up definitions for all defined terms)

Meeting Times - CTWG

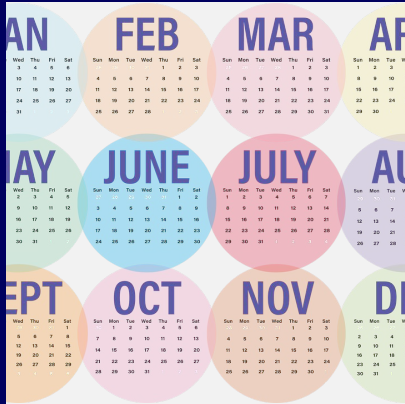

Every Alternate Monday

10:00 Pacific / 13:00 Eastern / 17:00 UTC

Subscribe on the ToIP Meeting Calendar

<https://wiki.trustoverip.org/display/HOME/Calendar+of+ToIP+Meetings#space-menu-link-content>



Open Discussion

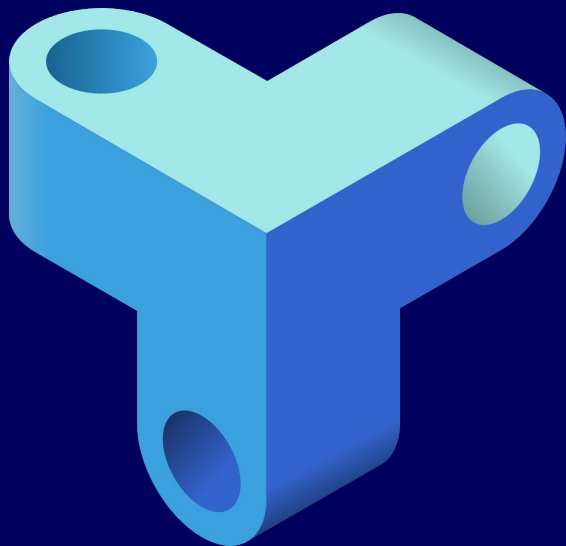

TRUST
Over **IP**
FOUNDATION